



**PEDAL BINS - Single colour**



**Ideal for hands-free refuse disposal.**

**A Food Service must.**

- Quiet, heavy-duty pedal mechanism.
- Tight-fitting, overlapping lid helps contain odours.
- Rounded corners and smooth contours for easy cleaning and disinfecting.
- Polypropylene durable construction won't rust or dent, chip or peel.
- 4 sizes of containers available 4 different colours or bicoloured.
- One set of 6 waste separation stickers delivered with each container.

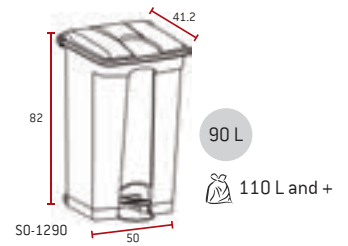
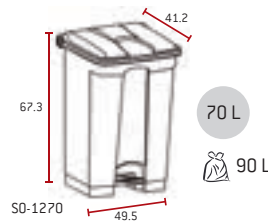
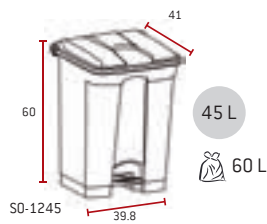
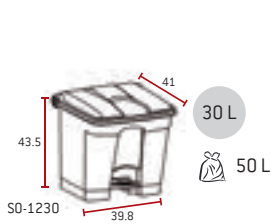

**SINGLE COLOUR**

Item Code	Description	Full Colour	Material
S0-1230-...	Pedal container 30 L	-GRY: Grey -WHT: White -RED: Red -YEL: Yellow	Polypropylene
S0-1245-...	Pedal container 45 L		
S0-1270-...	Pedal container 70 L		
S0-1290-...	Pedal container 90 L		

Example for a 30 L single red bin: S0-1230-RED

### PEDAL BINS - Dual colour



SO-1245-GBLU

SO-1290-GYEL



SO-1230-GRED

SO-1270-GGRN



#### Also great for waste separation.

- Grey body with coloured lid.
- White body with coloured lid.
- One set of 6 waste separation stickers delivered with each container.

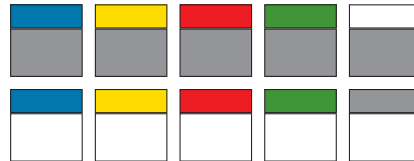

1



2



3

- 1 - Wide comfortable opening. Front ring for increased stability on 90 L version
- 2 - 90 L container fitted with rear wheels for easy transportation
- 3 - Robust pedal mechanism allows for use without touching

#### WASTE SEPARATION STICKERS

Associate a type of waste to the coloured lid of your choice. Each bin is delivered with a set of 6 stickers.

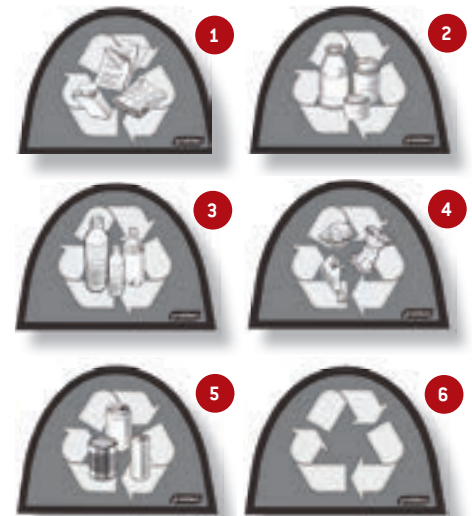

1. Paper / Carton
2. Glass
3. Plastic
4. Organic
5. Metal
6. Others

#### DUAL COLOUR

Item Code	Description	Body colour code	Lid colour code	Material
SO-1230...	Pedal container 30 L - Grey body + coloured lid	-G... : Grey	WHT : White RED : Red YEL : Yellow BLU : Blue GRN : Green	Polypropylene
SO-1245...	Pedal container 45 L - Grey body + coloured lid			
SO-1270...	Pedal container 70 L - Grey body + coloured lid			
SO-1290...	Pedal container 90 L - Grey body + coloured lid			
SO-1230...	Pedal container 30 L - White body + coloured lid	-W... : White	GRY : Grey RED : Red YEL : Yellow BLU : Blue GRN : Green	Polypropylene
SO-1245...	Pedal container 45 L - White body + coloured lid			
SO-1270...	Pedal container 70 L - White body + coloured lid			
SO-1290...	Pedal container 90 L - White body + coloured lid			

Example for a 30 L dual colour bin with grey body and red lid: SO-1230-GRED





**WASTE SEPARATION RECEPTACLES**



PB-1080-GRY



PB-1080-BLA\*



PB-1090-BLU



PB-1090-GRN



PB-1090-WHT



- 1 - Lids keep waste out of sight and allow use without touching
- 2 - Built-in handles for easy lifting and transportation
- 3 - Nestable

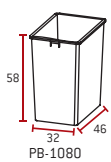

60 L

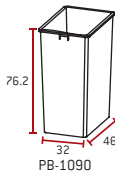

80 L

**The most complete waste separation system.**

- 2 container capacities.
- 5 colours.
- 11 different lids for effective waste separation.
- Designed to fit restricted and smaller spaces (e.g. under or next to a counter).
- Easy to clean and maintain.

Item Code	Description	Colour	Material
PB-1080-BLA*	Waste separation receptacle 60 L (no lid)	Black	Polypropylene
PB-1080-BLU	Waste separation receptacle 60 L (no lid)	Blue	Polypropylene
PB-1080-GRN	Waste separation receptacle 60 L (no lid)	Green	Polypropylene
PB-1080-GRY	Waste separation receptacle 60 L (no lid)	Grey	Polypropylene
PB-1080-WHT	Waste separation receptacle 60 L (no lid)	White	Polypropylene
PB-1090-BLA*	Waste separation receptacle 80 L (no lid)	Black	Polypropylene
PB-1090-BLU	Waste separation receptacle 80 L (no lid)	Blue	Polypropylene
PB-1090-GRN	Waste separation receptacle 80 L (no lid)	Green	Polypropylene
PB-1090-GRY	Waste separation receptacle 80 L (no lid)	Grey	Polypropylene
PB-1090-WHT	Waste separation receptacle 80 L (no lid)	White	Polypropylene

\*Made with > 70% recycled material

**Flat lids**



PB-1012-BLU



PB-1014-BLU



PB-1013-RED



PB-1012-GRN



PB-1014-YEL



PB-1013-YEL



PB-1011-GRY

**WASTE SEPARATION STICKERS**

Associate a type of waste to the coloured lid of your choice. Each lid is delivered with a set of 6 stickers.



1. Paper / Carton



2. Glass



3. Plastic



4. Organic



5. Metal



6. Others

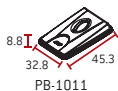

PB-1011

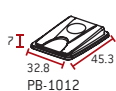

PB-1012

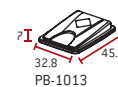

PB-1013

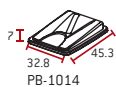

PB-1014

Item Code	Description	Colour	Material
PB-1011-GRY	"Universal" lid fits PB-1080 and PB-1090	Grey	Polypropylene
PB-1012-BLU	"Cans &/or bottles" lid fits PB-1080 and PB-1090	Blue	Polypropylene
PB-1012-GRN	"Cans &/or bottles" lid fits PB-1080 and PB-1090	Green	Polypropylene
PB-1013-RED	"Universal" lid with square opening fits PB-1080 and PB-1090	Red	Polypropylene
PB-1013-YEL	"Universal" lid with square opening fits PB-1080 and PB-1090	Yellow	Polypropylene
PB-1014-BLU	"Paper" lid fits PB-1080 and PB-1090	Blue	Polypropylene
PB-1014-YEL	"Paper" lid fits PB-1080 and PB-1090	Yellow	Polypropylene





**Dome lids**



PB-1081-GRY-LID



PB-1082-GRY-LID



PB-1083-GRY-LID



Item Code	Description	Colour	Material
PB-1081-GRY-LID	"Push" lid fits PB-1080 and PB-1090	Grey	Polypropylene
PB-1082-GRY-LID	"Cans and/or bottles" lid fits PB-1080 and PB-1090	Grey/Yellow	Polypropylene
PB-1083-GRY-LID	"Paper" lid fits PB-1080 and PB-1090	Grey	Polypropylene

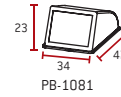

PB-1081

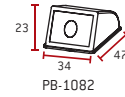

PB-1082

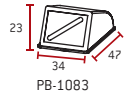

PB-1083

**Locking kit**



Locking system to prevent unauthorised access to critical waste.



PB-1000-BLA



Front



Back

Item Code	Description	Colour	Material
PB-1000-BLA	Locking kit for waste separation receptacles	Black	Epoxy

**Dollies**

**Link dollies to create a mobile waste station.**

- Dollies available in plastics or metal.
- Easy transportation of full containers.
- Fitted with swivel casters (2 with breaks on PB-1001-BLA).



PB-1001-BLA



PB-1002-BLA



Item Code	Description	Colour	Material
PB-1001-BLA	Dolly fits PB-1080 & -1090	Black	Epoxy
PB-1002-BLA	Dolly fits PB-1080 & -1090	Black	Polypropylene

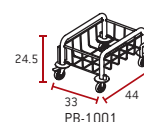

PB-1001

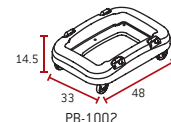

PB-1002



**WALL MOUNTED BINS**



Wall mounting set

**Ideal for sanitary environments .**

- 2 different wall mounting sets fit with 4 bin capacities (PB-1005 for 60 & 80 L – PB-1105 for 25 & 40L).
- Easy to clean underneath.
- Optional swing lids available (PB-1021 fits the 60 & 80L, PB-1121 fits 40L).
- Works with all waste containers displayed on page 24.

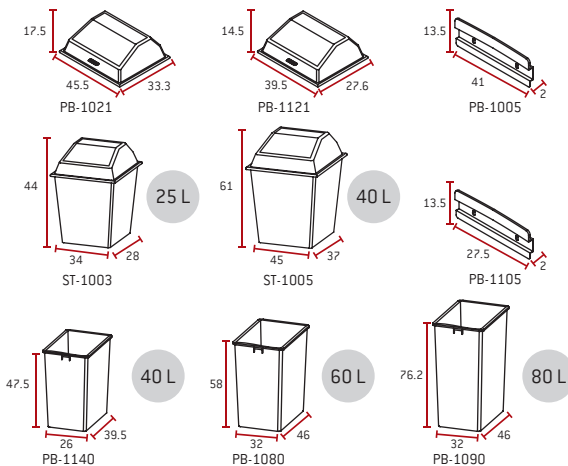

Item Code	Description	Colour	Material
PB-1005-DGRY	Wall mounting set fits PB-1080 & PB-1090	Dark Grey	Epoxy
PB-1021-GRY	Swing top lid fits PB-1080 & PB-1090	Grey	Polypropylene
PB-1021-WHT	Swing top lid fits PB-1080 & PB-1090	White	Polypropylene
PB-1080-GRY	Recycling bin 60 L	Grey	Polypropylene
PB-1080-WHT	Recycling bin 60 L	White	Polypropylene
PB-1090-GRY	Recycling bin 80 L	Grey	Polypropylene
PB-1090-WHT	Recycling bin 80 L	White	Polypropylene
PB-1105-DGRY	Wall mounting set fits PB-1140, ST-1003 & ST-1005	Dark Grey	Epoxy
PB-1121-GRY	Swing top lid fits PB-1140	Grey	Polypropylene
PB-1121-WHT	Swing top lid fits PB-1140	White	Polypropylene
PB-1140-GRY	Recycling bin 40 L	Grey	Polypropylene
PB-1140-WHT	Recycling bin 40 L	White	Polypropylene
ST-1003-GRY	Swing Top bin 25 L - Lid included	Grey	Polypropylene
ST-1005-GRY	Swing Top bin 40 L - Lid included	Grey	Polypropylene

### MOBILE CONTAINERS

#### Heavy-duty containers, suitable for heavy loads.

- Durable plastic construction, impact and rust resistant in indoor or outdoor conditions.
- Reinforced rims for added strength and durability.
- Built-in handles allow for non-slip lifting and avoid jamming when the containers are stacked or nested.
- Double-ribbed base for increased stability and dragging capacity.
- Swivel caster dolly and clip on lid sold separately.
- Thermal resistance -29°C to + 60°C.



Dolly screws securely to the base of the container

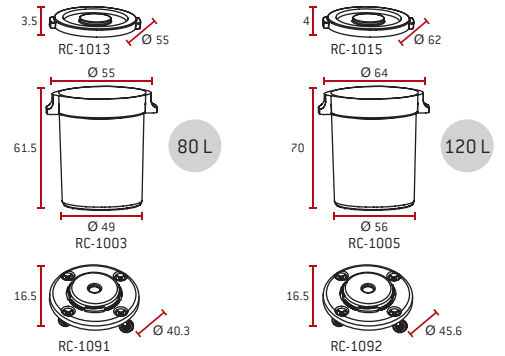

Item Code	Description	Colour	Material
RC-1003-GRY	Round container 80 L	Grey	Polypropylene
RC-1005-GRY	Round container 120 L	Grey	Polypropylene
RC-1013-GRY	Snap-on lid fits RC-1003	Grey	Polypropylene
RC-1015-GRY	Snap-on lid fits RC-1005	Grey	Polypropylene
RC-1091-GRY	Round dolly fits RC-1003 (4 wheels)	Grey	Polypropylene/Metal
RC-1092-GRY	Round dolly fits RC-1005 & RC-1007 (5 wheels)	Grey	Polypropylene/Metal

#### Food contact approved containers\* available in various colours.

- Soft grip, built-in handles for non-slip lifting and avoid jamming when the containers are stacked or nested.
- Special bin structure helps removal of heavy waste bags.
- Platform dolly and clip on lid sold separately.
- Transport platform dolly extends to fit both container sizes.
- Thermal resistance -50°C to +105°C.



Item Code	Description	Colour	Material
RC-2003-BLA	Round container 85 L	Black	Polyethylene
RC-2003-BLU		Blue	
RC-2003-GRN		Green	
RC-2003-GRY		Grey	
RC-2003-RED		Red	
RC-2003-WHT	White		
RC-2003-YEL	Yellow		
RC-2005-BLA	Round container 120 L	Black	
RC-2005-GRN		Green	
RC-2005-GRY		Grey	
RC-2005-RED		Red	
RC-2005-WHT		White	
RC-2005-YEL	Yellow		
RC-2013-BLA	Snap-on lid for RC-2003	Black	
RC-2013-GRN		Green	
RC-2013-GRY		Grey	
RC-2013-RED		Red	
RC-2013-WHT		White	
RC-2013-YEL	Yellow		
RC-2015-BLA	Snap-on lid for RC-2005	Black	
RC-2015-GRN		Green	
RC-2015-GRY		Grey	
RC-2015-RED		Red	
RC-2015-WHT		White	
RC-2015-YEL	Yellow		
RC-2025-GRY	Funnel lid for RC-2005	Grey	
RC-2092-BLA	Dolly for RC-2003 & RC-2005 (4 castors)	Black	Polyethylene/Metal



Made in Europe & food contact approved\*  
\*Except black and green containers and lids.

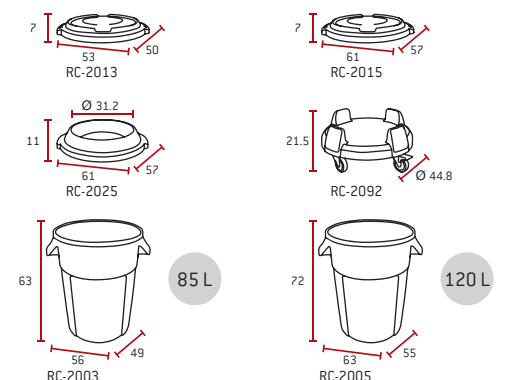



## ROLL OUT CONTAINERS



RO-2100-BYEL



RO-2100-BBLA



RO-2100-BGRN



RO-2100-BBLU



RO-2100-BRED



RO-2100-BGRY



RO-2110-BBLU



**Designed for indoor & outdoor use in industrial environments.**

- One hand, extra wide opening.
- Waterproof lid available in 6 different colours.
- Lid folds back at 270°.
- Integrated bag holder.
- Large recessed wheels for mobility and easy cleaning.
- Lockable with padlock (not included).

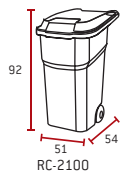

100 L

RC-2100

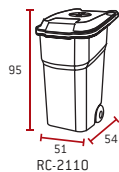

100 L

RC-2110

Item Code	Description	Colour	Material
RO-2100-BBLA	Roll-out container 100 L with black lid	Black	Polypropylene
RO-2100-BBLU	Roll-out container 100 L with blue lid	Black/Blue	Polypropylene
RO-2100-BGRN	Roll-out container 100 L with green lid	Black/Green	Polypropylene
RO-2100-BGRY	Roll-out container 100 L with grey lid	Black/Grey	Polypropylene
RO-2100-BRED	Roll-out container 100 L with red lid	Black/Red	Polypropylene
RO-2100-BYEL	Roll-out container 100 L with yellow lid	Black/Yellow	Polypropylene
RO-2110-BBLU	Roll-out container 100 L with bottle lid	Black/Blue	Polypropylene

## WASTE BIN WITH LID



RC-0070-BLA



70 L

RC-0070

**Classic waste container with clipable lid.**

- Durable construction which will not chip or peel.
- Integral handles for easy lifting.
- Clipable lid to contain odours.

Item Code	Description	Colour	Material
RC-0070-BLA	Waste bin 70 L with lid	Black	Polypropylene